

## Nexus Tall Shoe Shelving

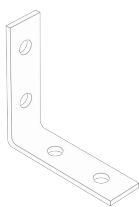

Assembly Hardware

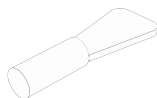

Recommended Tools

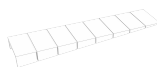
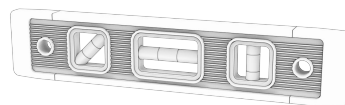

### 1 Take Inventory.

Locate your Parts List in the Design Guide.

The goal of this step is to make sure no parts are missing. If you find an issue, contact Customer Service using the information at the bottom of this page.

Go down the Components Section of the Parts List and check off items as you take inventory. Set aside any part whose label contains the term "Vertical" or "Fixed".

Did you order more than one design? To reduce packaging waste, product from different designs may be mixed in a single box. The box label will list which parts are contained inside each box.

### 2 Preparation.

Take to the install area:

- a) Any part whose label contains the term "Vertical" or "Fixed"
- b) The "Open First" box(es)
- c) Any additional boxes containing only hardware
- d) Tools
- e) Remove or cutaway sections of base moulding to ensure panels fit tightly to wall.
- f) Your enthusiasm!

### 3 Install hardware.

Refer to the correct Hardware Diagram in your Design Guide to select the correct verticals and see your hardware locations.

### 4 Install hardware (continued).

Lay first vertical onto protective cardboard. Install hardware per Hardware Diagram (use M20 Connecting on End Panels, use Double Cam Screw on Shared Panel). Flip vertical over and repeat for other side if necessary. Install hardware for all verticals in this PHASE.

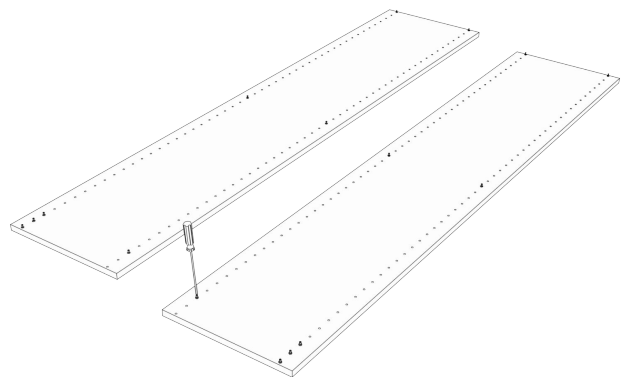

### 5 Place verticals.

Place verticals in approximate location per design. Start in corner if there is one.

Vertical panels and baseboard molding.

To accommodate your baseboard molding, you must either 1) remove it during installation, or 2) cut the vertical panels and possibly bottom fixed shelves.

**Note:** After installing your organizer, reinstall pieces of the molding in any areas not covered by the units.

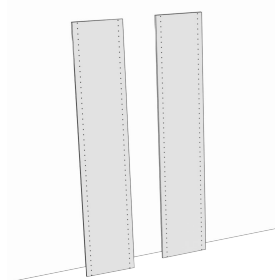

### 6 Install top fixed shelf onto first vertical.

Refer to the top of the Shelves and Cleats diagram in the Design Guide for shelf width. It is easiest if one person positions shelf onto cam screws while holding shelf level as the other person locks into place. Holding the Phillips screwdriver at a slight (15°) angle, lock fixed shelf with 1/4-1/2 turn of screwdriver. **DO NOT FORCE.**

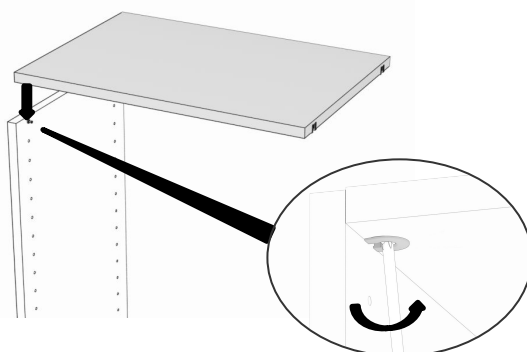

### 7 Install second vertical.

Move second vertical into fixed shelf. Lock other end of top fixed shelf to vertical.

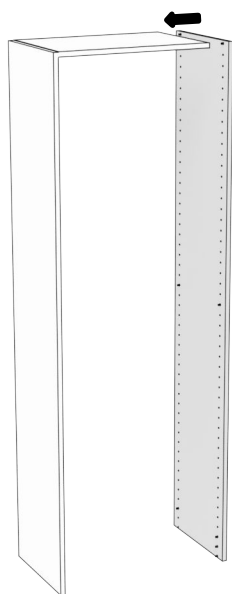

### 8 Place and Lock remaining fixed shelves according to the shelves and cleats diagram.

**Note:** Use small screwdriver for bottom shelf. Tighten back two cams first by tilting front of shelf up slightly.

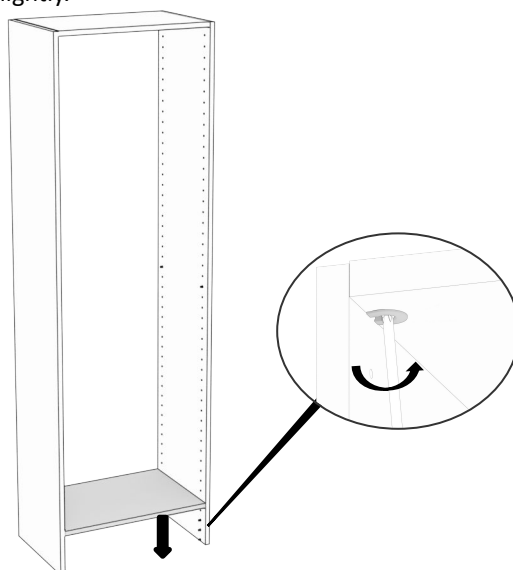

**9** Place and lock remaining fixed shelves.

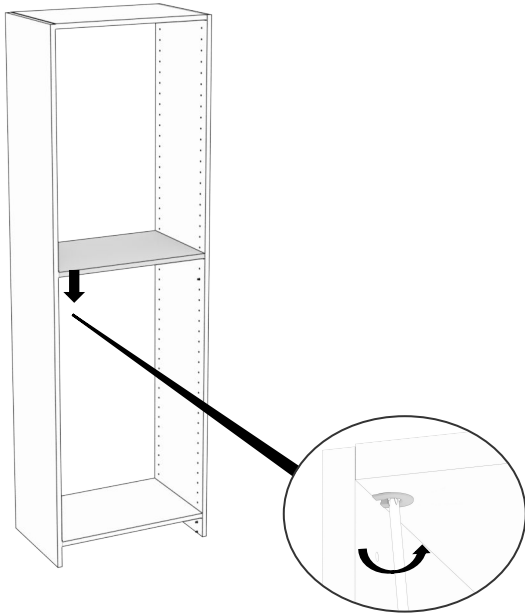

**10** Review all floor sections when leveling.

Your goal is to get all floor sections to be level and plumb with each other. Use a level with straight 2 x 4 as needed to find which floor section is highest.

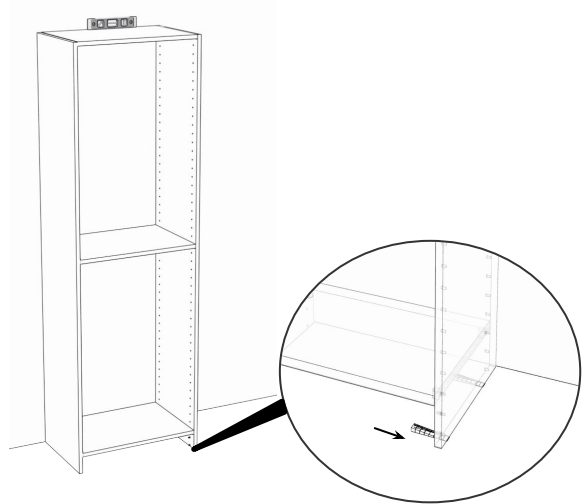

**11** Secure the highest floor section.

Use stud finder to locate attachment points for L-bracket in a less visible spot. Use two (2)  $\frac{3}{8}$ " screws to attach L-bracket to highest floor section and a 2" screw to attach to stud.

**IMPORTANT:** If you have mixed floor and rail mounted product directly touching each other-do not attach L-brackets until you verify that the Floor mounted product is in the exact location on the wall. Look ahead to the Install Rails Phase and allow room for rails when placing Floor mounted product.

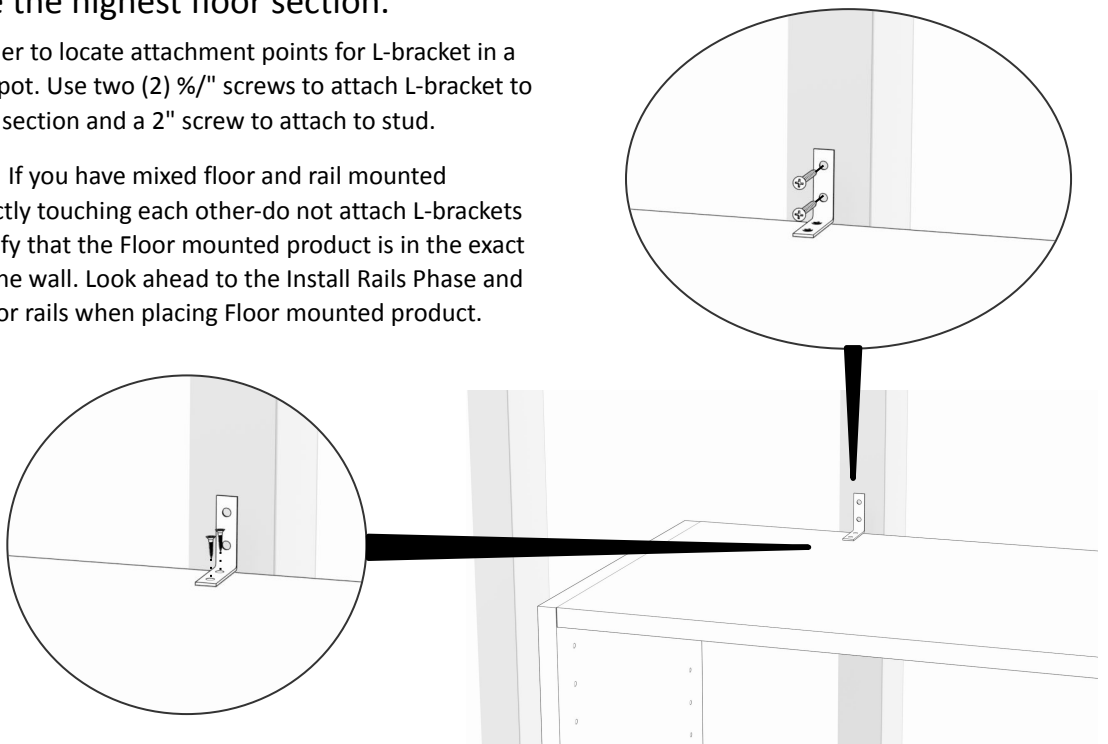

### 12 Install hardware.

Using the hole counting tape, install shelf pins at same height location in 4 places.

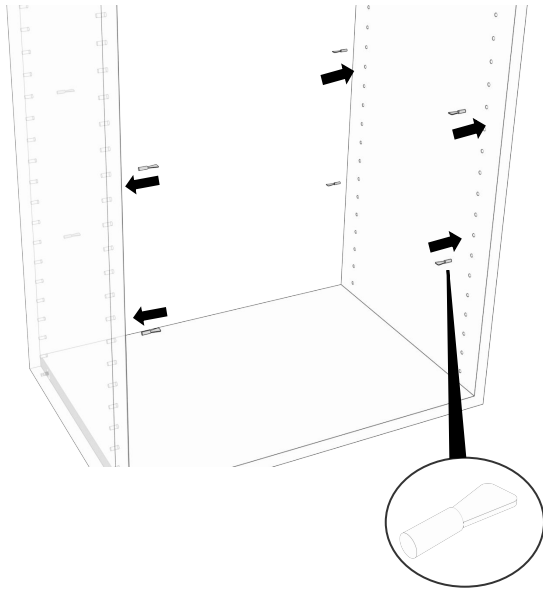

### 13 Place shelf on pins, finished edge facing out.

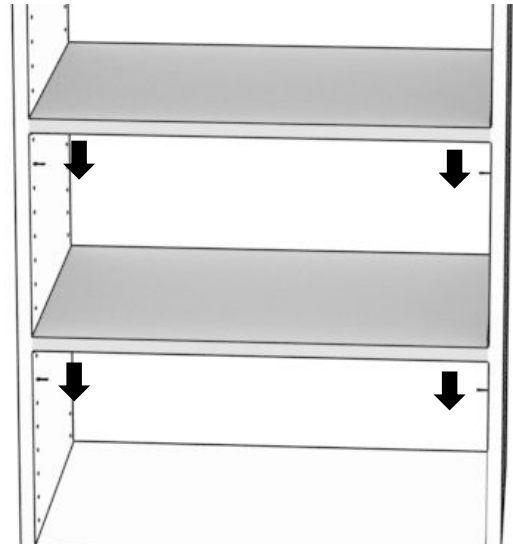

### 14 Slide toe kick under bottom shelf until it snaps into place.

